

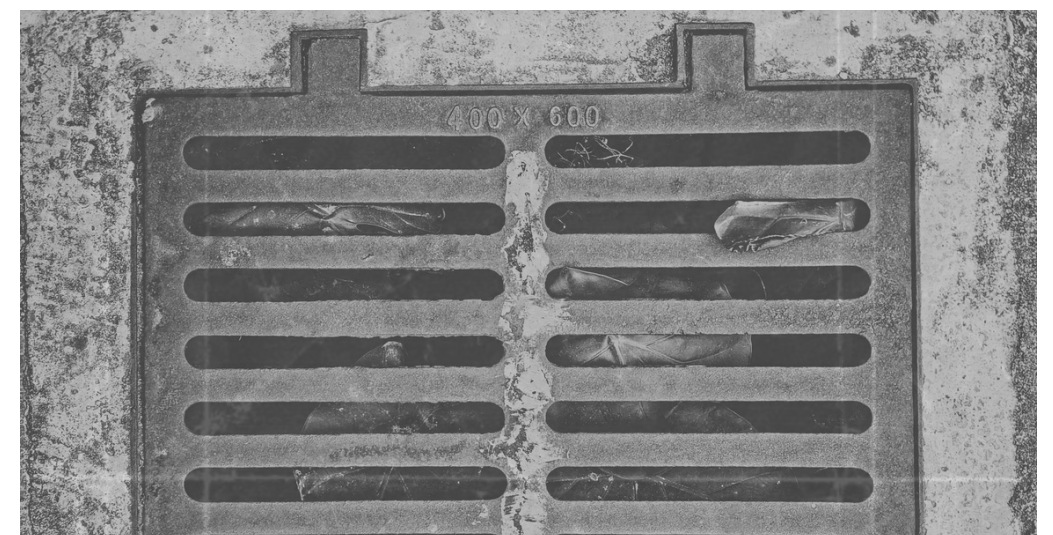

fiip

fundición industrial potosina s.a

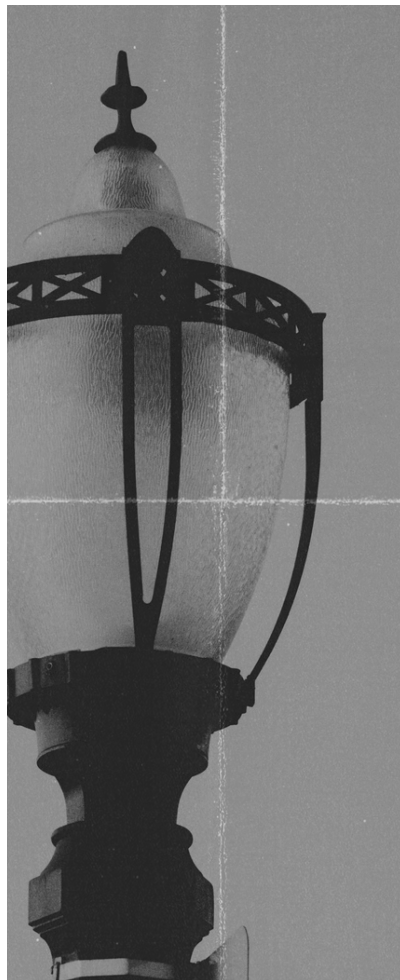
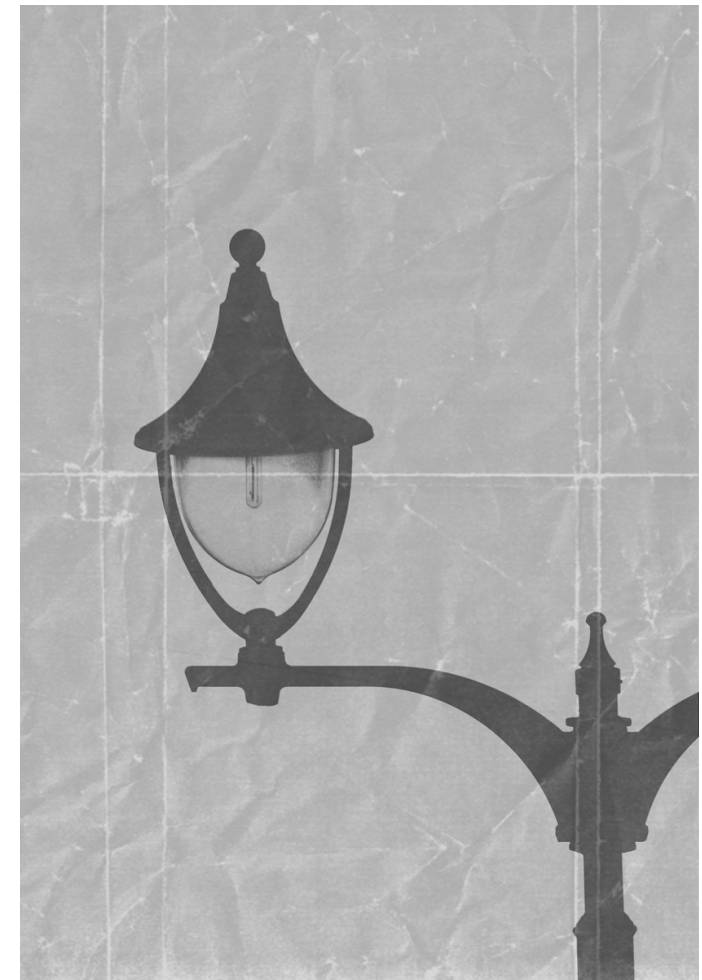

P O R T A F O L I O



**PRINCIPALES
PRODUCTOS**

 **Discos de embrague y maquila SKF**

 **Industria automotriz**

 **Engranés para sistemas de transmisión**

 **Bujes y barretones de cualquier medida y especificación**

 **Poleas para transmisión mecánica y automática.**

 **Bombas para extracción de agua desde 1/4 de pulgada hasta 4.**

 **Equipo de maquinaria y minería**

 **Contrapesos**

TODO PARA SISTEMA DE ALCANTARILLADO

 **Bocas de tormenta**

 **Rejillas de piso**

 **Registros para bomberos**

 **Registros pozo de visita**

 **Registros eléctricos C.F.E 84-A y 84-B**

 **Registros para válvula de agua**

Tapa de 823 mm de Diámetro

Tapa de 823 mm de Diámetro

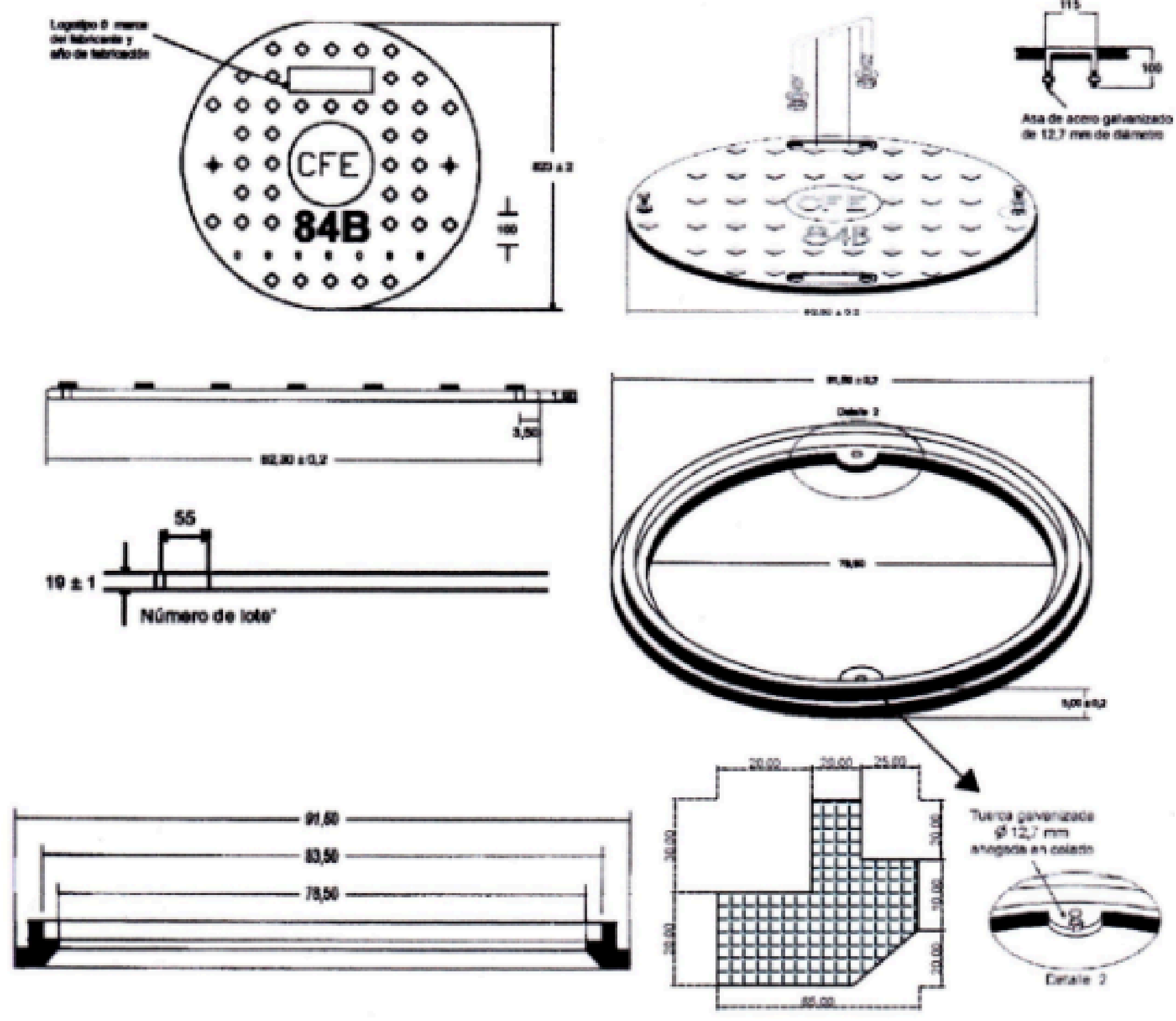
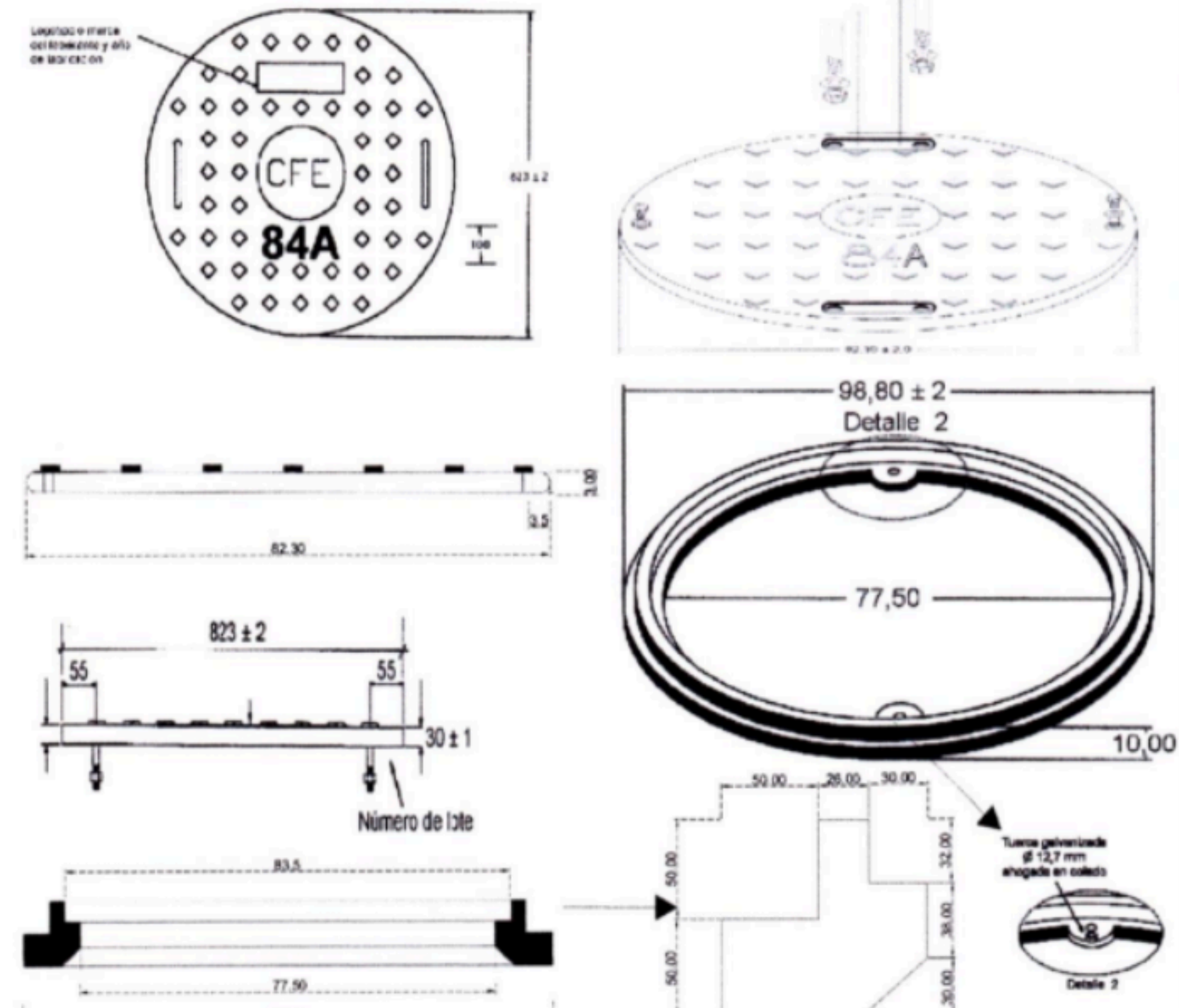



**MOBILIARIO
URBANO**

 Bancas en diferentes estilos

 Basureros

 Bolardos

 Luminarias

 Barandales

 Placas conmemorativas de
bronce y aluminio



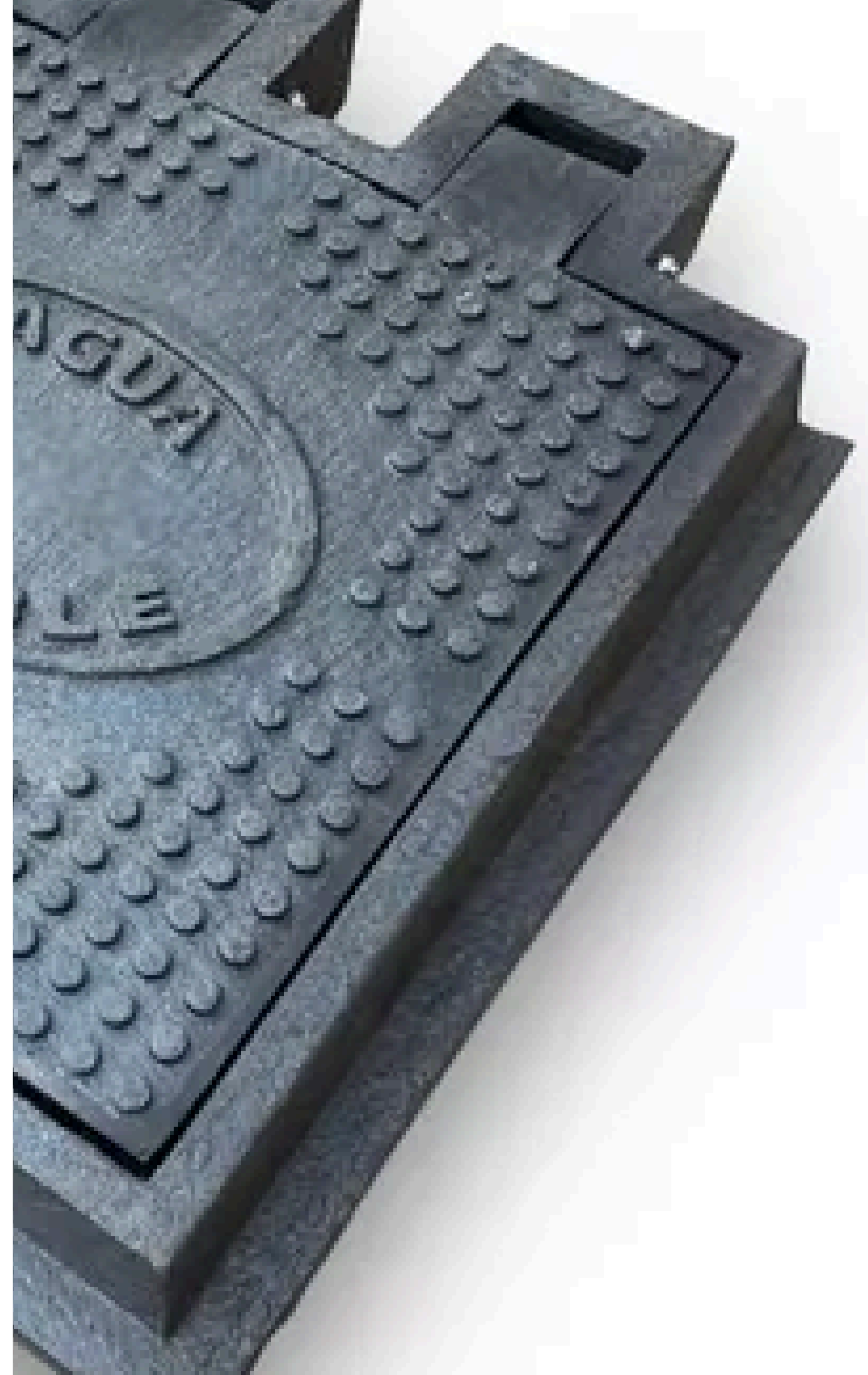
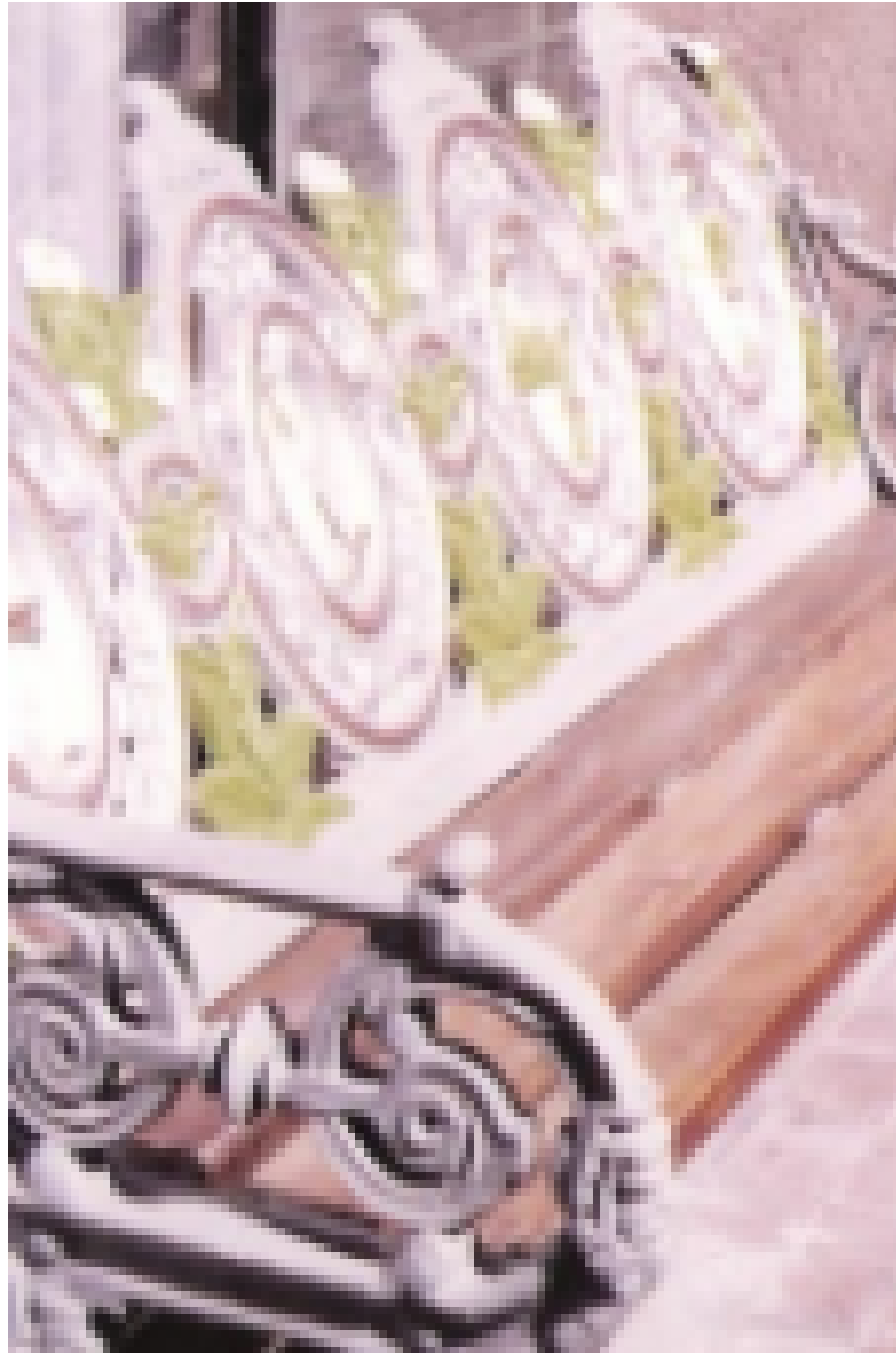

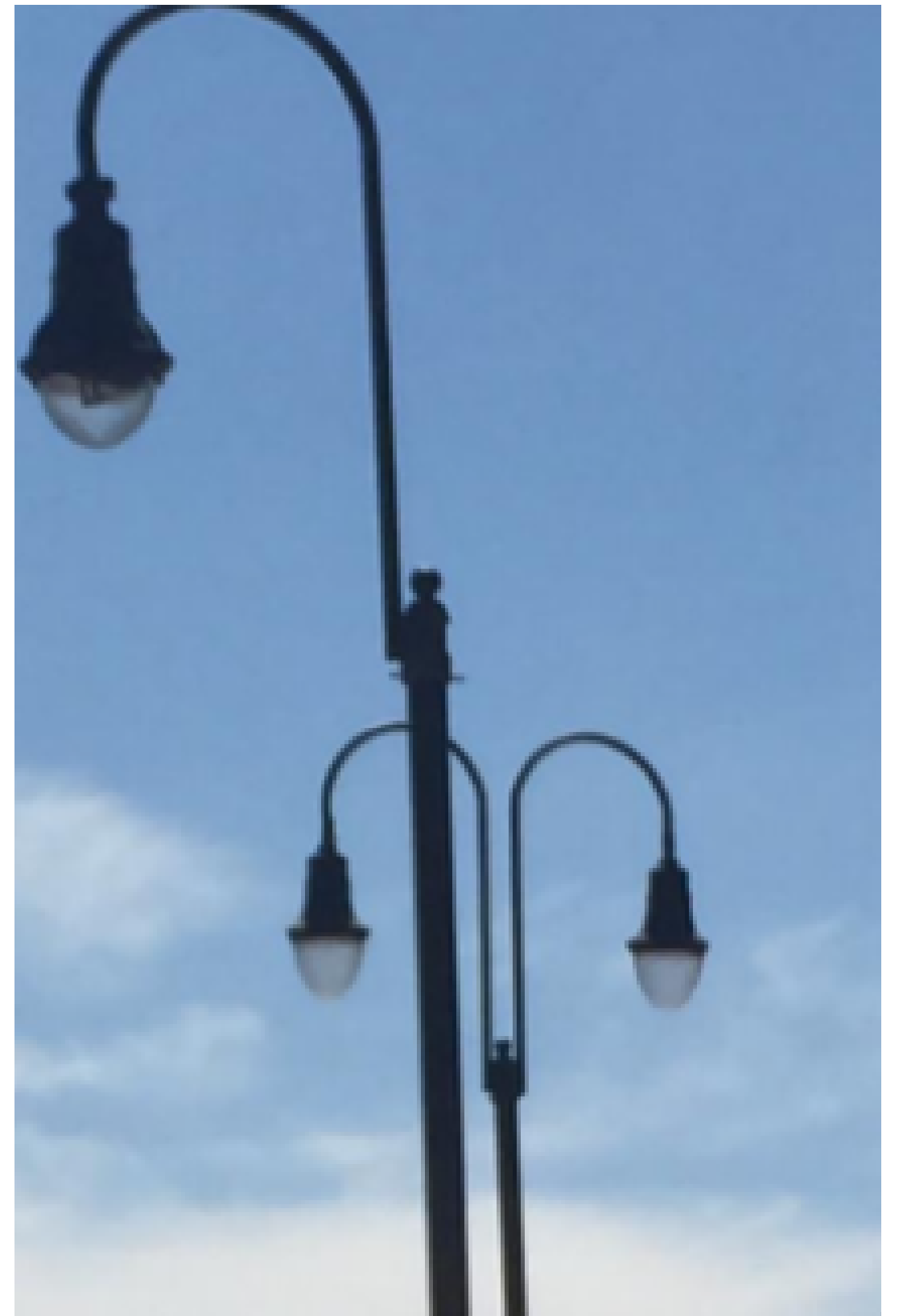
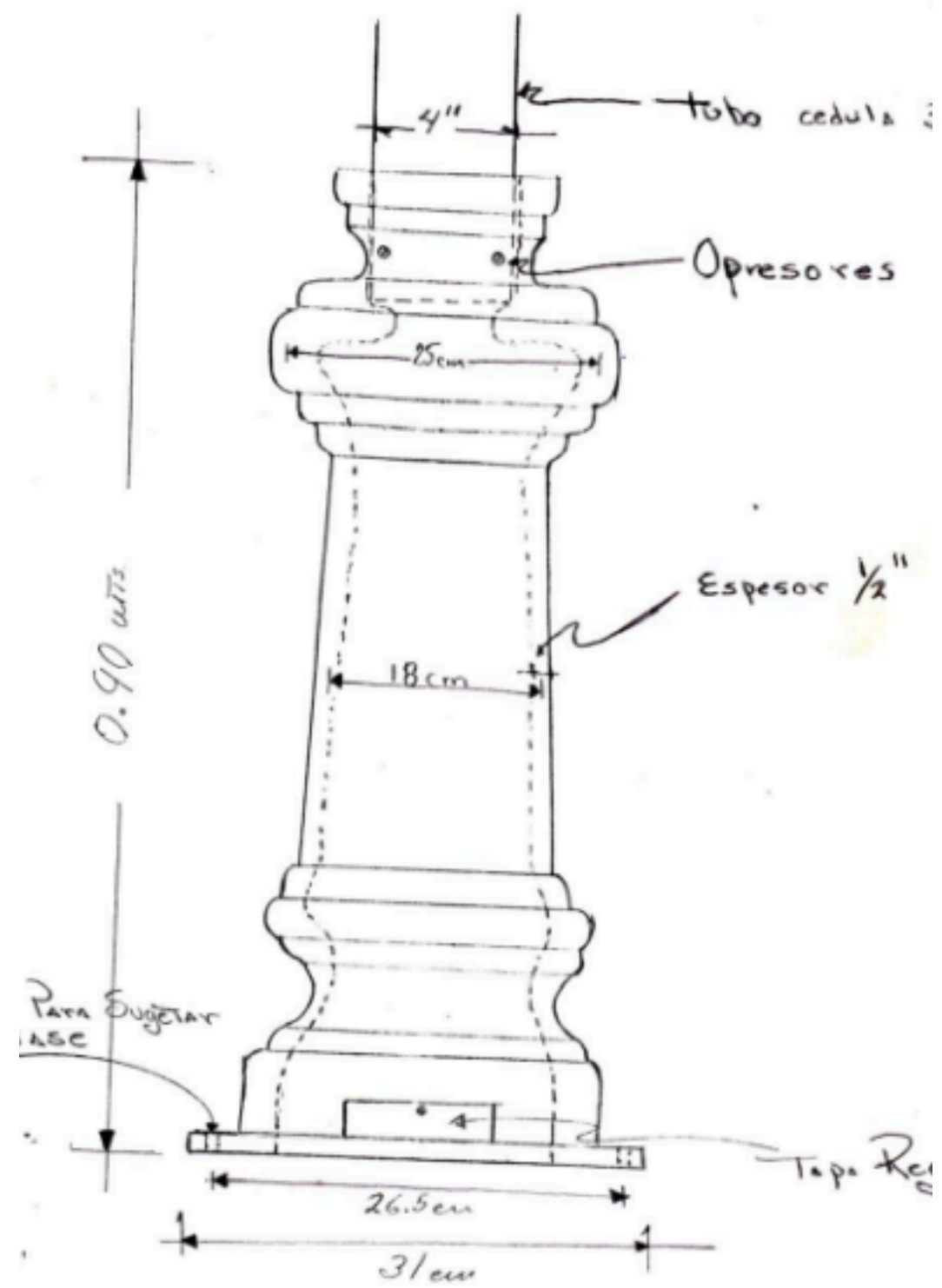
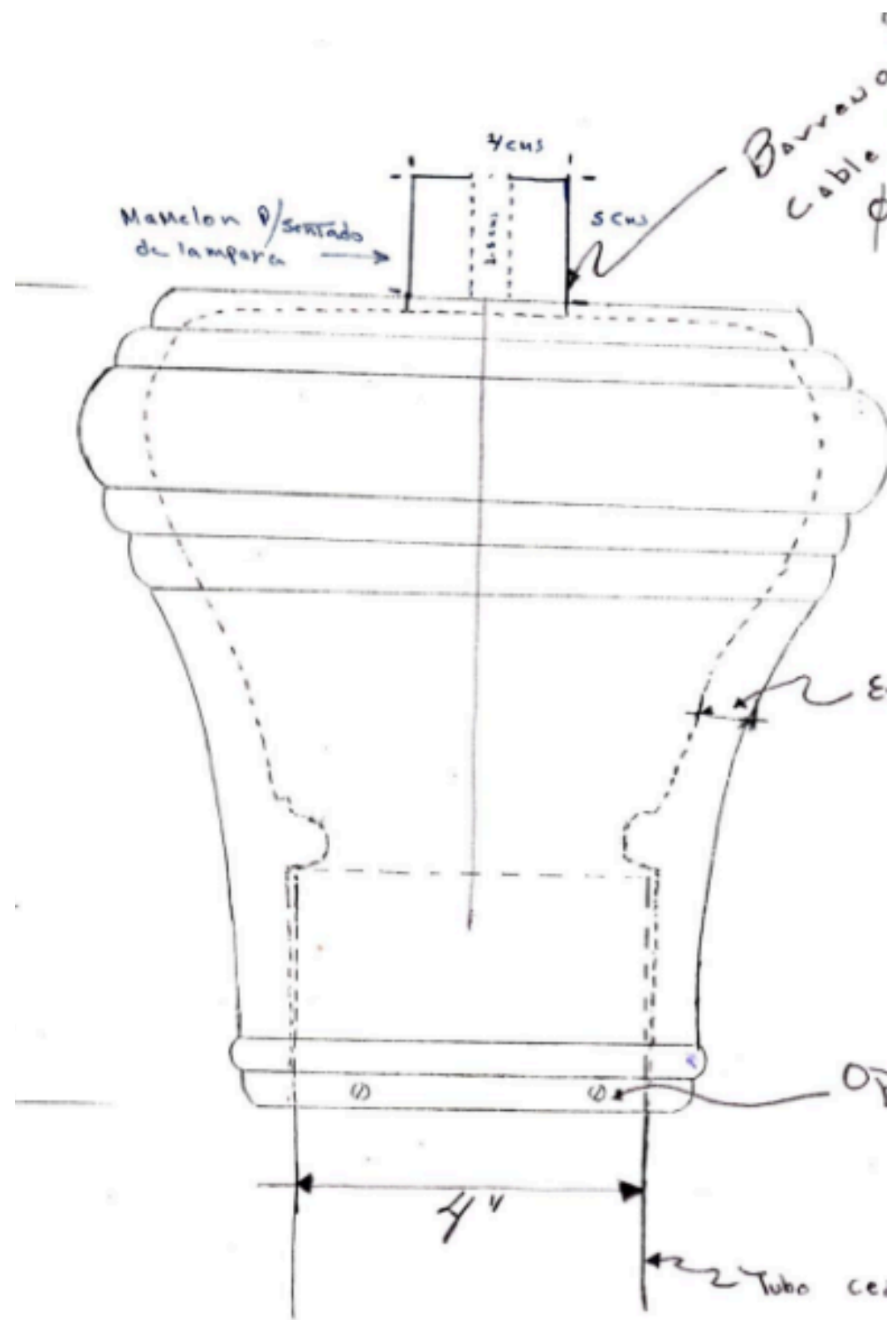

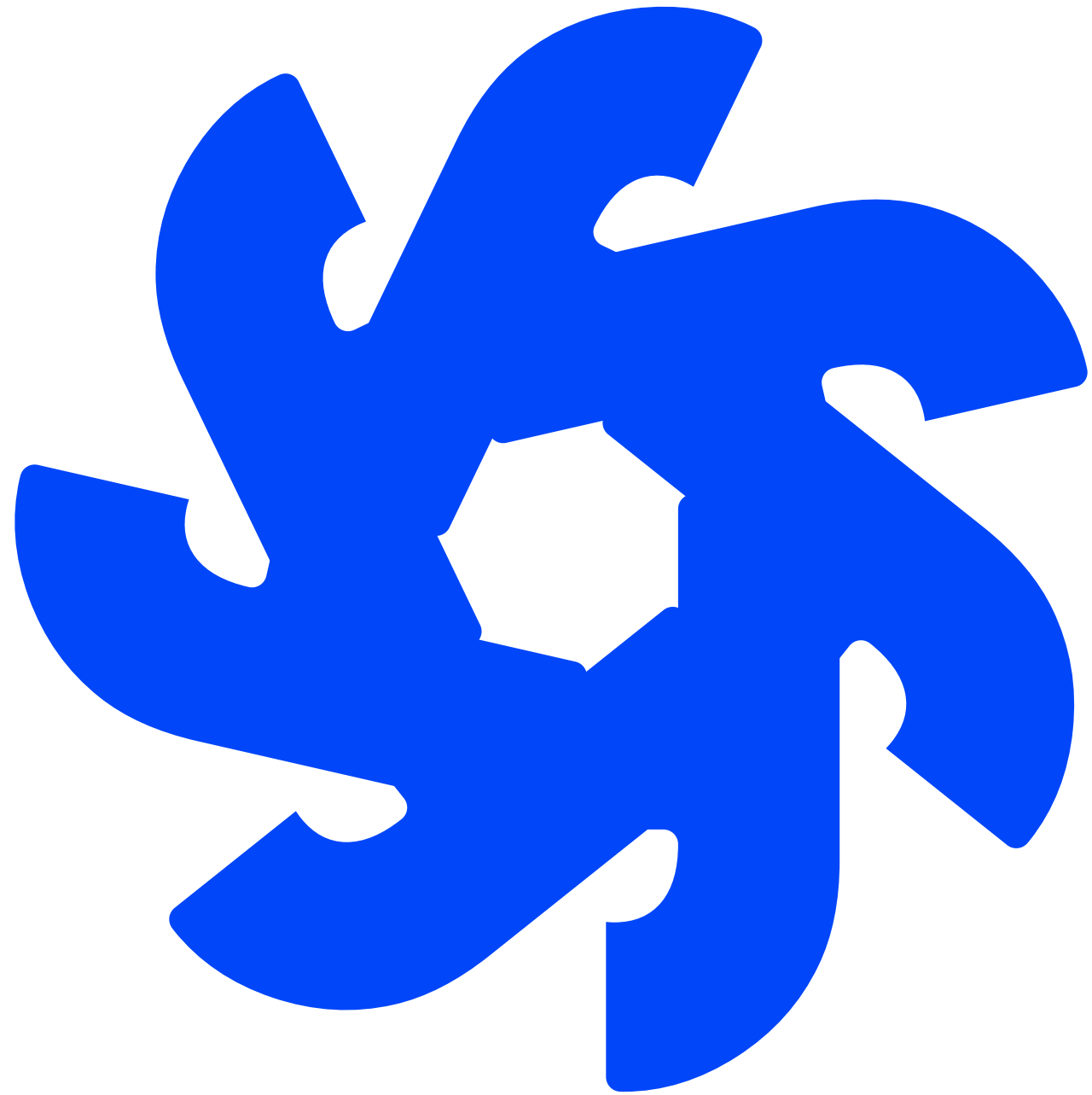

fiip

fundición industrial potosina s.a